

Ex9L

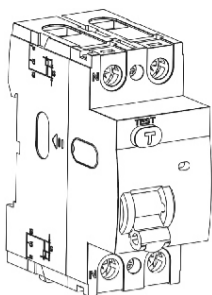

RCCB  
Proudový chránič  
Prúdový chránič  
Wyłącznik różnicowoprądowy  
Interrupator diferencial  
FI-Schalter  
Interrupteur différentiel  
УЗО  
Diferencijalna zaštitna sklopka

NOARK

Ex9L

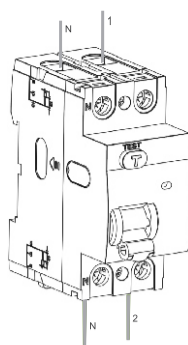

		Z2
		1-35mm <sup>2</sup>
		2.5Nm

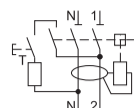

1

7

Ex9L

Mounting instructions  
Montážní návod  
Montážne inštrukcie  
Instrukcja montażu  
Instrucțiuni de asamblare  
Montageanweisung  
Instructions de montage  
Инструкция по монтажу  
Monteringsanvisning  
Istruzioni di montaggio  
Instrucciones de montaje  
Ősszeszerelési útmutató  
Uputstvo za montažu

Asennusohjeita  
Montage-instructies  
Instruções de montagem  
Navodila za montažo  
Οδηγίες Εγκατάστασης  
Инструкции за инсталиране  
Monteringsvejledningen  
Montažu upute  
Surinkimo instrukcijos  
Instalēšanas instrukcijas  
Скупштина упутство  
Paigaldusjuhendid

2

8

Ex9L

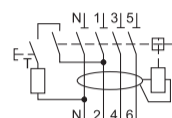
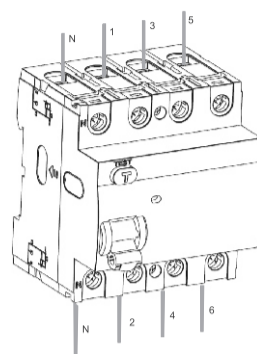

Ex9L

3

Caution: Installation by electricians only  
Varování: Montáž pouze osobou s elektrotech. kvalifikací  
Varovanie: Montáž iba osobou s elektrotech. kvalifikáciou  
Uwaga: Montaż tylko przez uprawnionych instalatorów  
Atenție: Instalare numai de către electricieni  
Vorsicht: Montagenur durch Elektrofachkräfte  
Осторожно: Монтаж только электрика  
Upozorenje: Montažu izvodi samo stručno lice

Ex9L

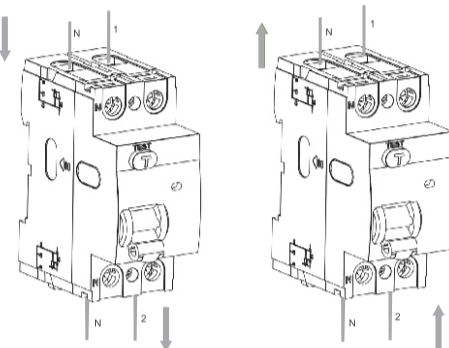

9

Ex9L

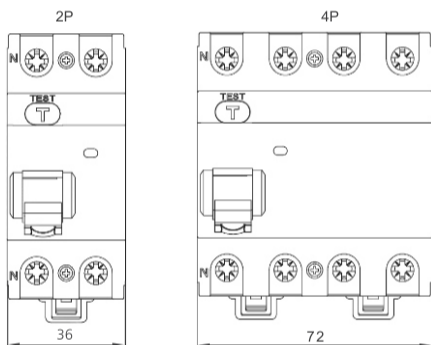

4

Ex9L

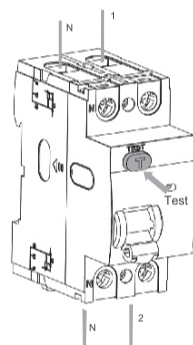

10

Test monthly  
Testovat měsíčně  
Testovať mesačne  
Test miesięcznie  
Test lunar  
Test månedlige  
Test mensuelle  
Испытание ежемесячно  
Mesečno testirati

Ex9L

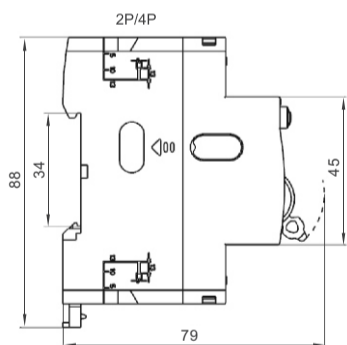

Ex9L

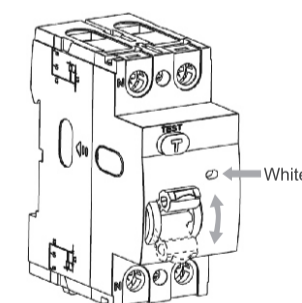

11

White  
Bílá  
Biela  
Biało  
Albă  
Weiss  
Blanc  
Белая  
Bela

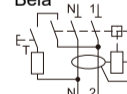

Ex9L

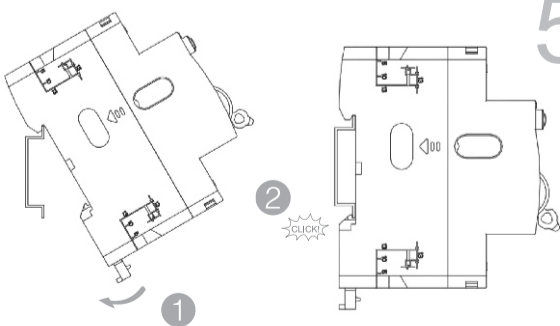

5

Ex9L

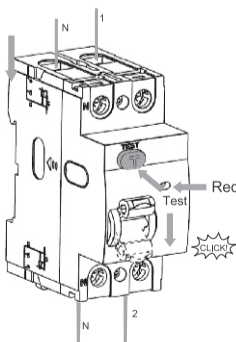

12

Red  
Červená  
Czerwoný  
Roșu  
Rot  
Rouge  
Красный  
Crvena

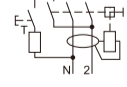

Ex9L

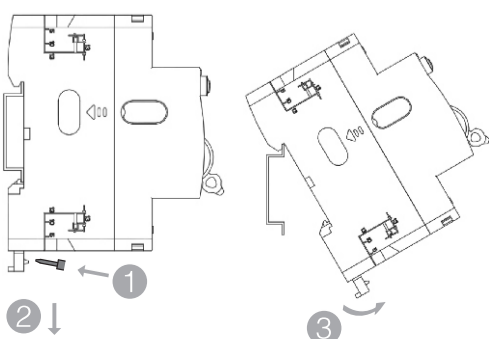

6

NOARK



Printed with environment-friendly paper  
Copyright Noark. All Rights Reserved  
Manufacturer: NOARK Electric (Shanghai) Co., Ltd.  
3857 Sixian Road, Songjiang District, Shanghai  
Importer: NOARK Electric Europe s.r.o. Sezemická  
2757/2 | 193 00 Praha 9 | Czech Republic  
www.noark-electric.eu  
Z9L201710EU